

Varenummer: 025849160038  
Beskrivelse: Norma Connect rørkobling  
COMBI GRIP GL W2 Ø38,0/40 EPDM 16 bar

## Mål

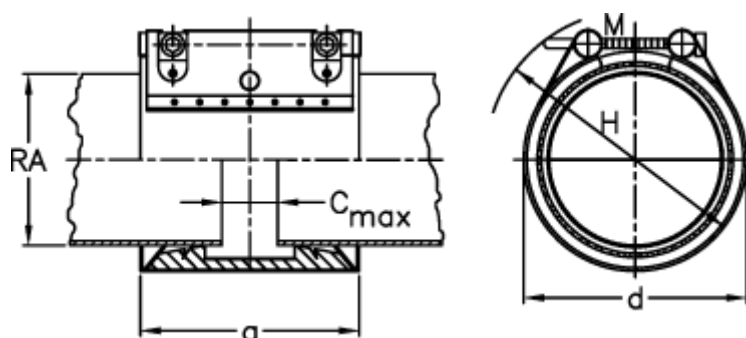

a	= 62.4	RA min-RA max metal = 37,5-39,0
C max med båndindlæg	= 8	Vægt pr stk. = 0.6
d	= 60	
H	= 80	
M (Skrue)	= M8	
Nominelt tryk (bar)	= 16	
RA	= 38,0/40,0	
RA min-RA max kunststof	= 39,5-40,5	